

Salamander Pumps



EVE

Pump Installation and Warranty Guide



ISSUE A

Pump installation and warranty guide for EVE

! Important – read this first!

● Safety in Operation

These appliances are not intended for use by persons (including children) with reduced physical, sensory, or mental capabilities, or lack of experience or knowledge, unless they have been given supervision or instruction concerning use of the appliance by a person responsible for their safety.

Children should be supervised to ensure that they do not play with the appliance.

If the supply cord is damaged, it must be replaced by the manufacturer, its service agent, or similarly qualified person in order to avoid a hazard.

Correct installation is the guarantee of safety and a trouble free system. It is therefore important to read these instructions thoroughly and ensure you comply with them. Incorrect fitting can invalidate the warranty.

This manual provides clarification of some of the more unusual installation requirements. If your installation is complicated or you have any questions please CONSULT THE PUMPWISE HELPLINE IMMEDIATELY.

We encourage installers to consult the Salamander helpline, where our advisors can give you first-rate advice regarding installation.

Please leave this installation guide with the customer for reference to maintenance and safety information.

*Thank you for choosing
Salamander Pumps*

Contents

What can EVE do?	4
Getting to know EVE	5
Assembling EVE	7
Pre-installation checklist	8
Installation instructions	9
Typical installations	10
Operating instructions	13
Mode selection	14
General specification	15
Trouble shooting	17
PumpWise and warranty	19
To the installer	20

What can EVE do?

1. EVE has an EPV – Electronic Pressure Vessel. This monitors the system pressure and when a slow small leak is detected it automatically re-pressurises the system
2. EVE has 3 selectable modes
1.5bar
2.0bar
3.0bar
3. EVE speeds up when more Water is needed. The graph shows how EVE's output pressure remains constant as the output flow increases. Standard pumps lose pressure.

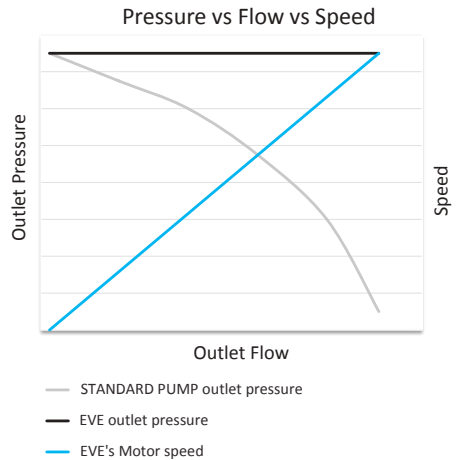
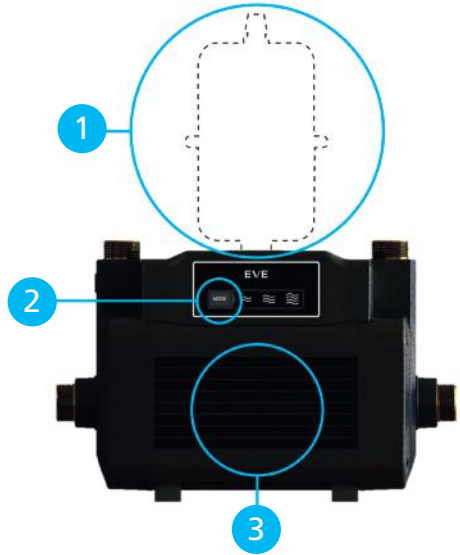

Getting to know EVE



- 1. Hot or cold outlet
- 2. Hot or cold outlet
- 3. Hot or cold inlet
- 4. Hot or cold inlet
- 5. MODE panel
- 6. Warranty information
- 7. Rating label
- 8. X4 Vibration dampening feet

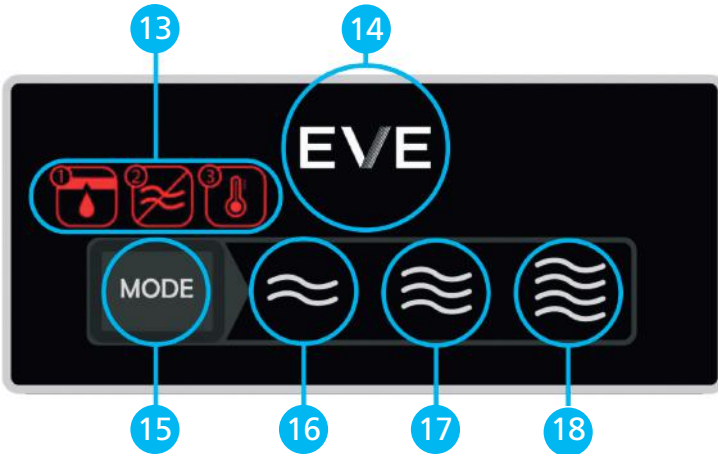
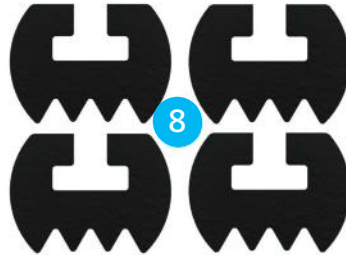
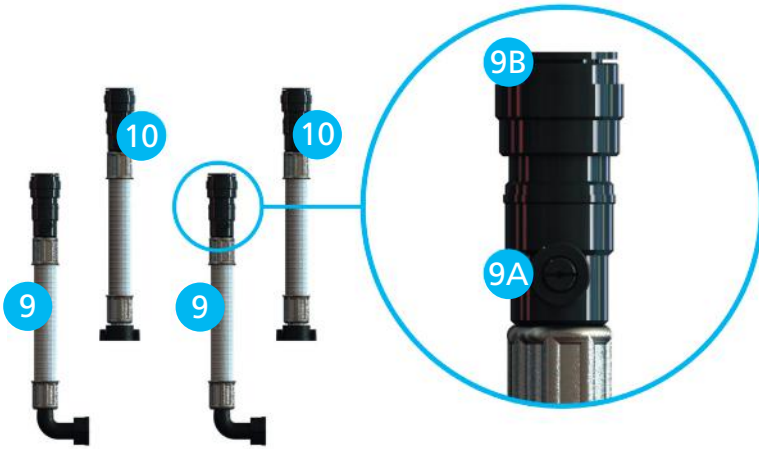

- 9. X2 Angled 22mm coupler with iso push fit
- 9A. Isolation valve
- 9B. Pipe release collar
- 10. X2 Straight 22mm coupler with iso push fit
- 11. X2 Outlet rubber washers
- 12. X2 Inlet filter washers

- 13. ERROR lights
- 14. Power indicator
- 15. MODE selector
- 16. MODE 1
- 17. MODE 2
- 18. MODE 3

Assembling EVE

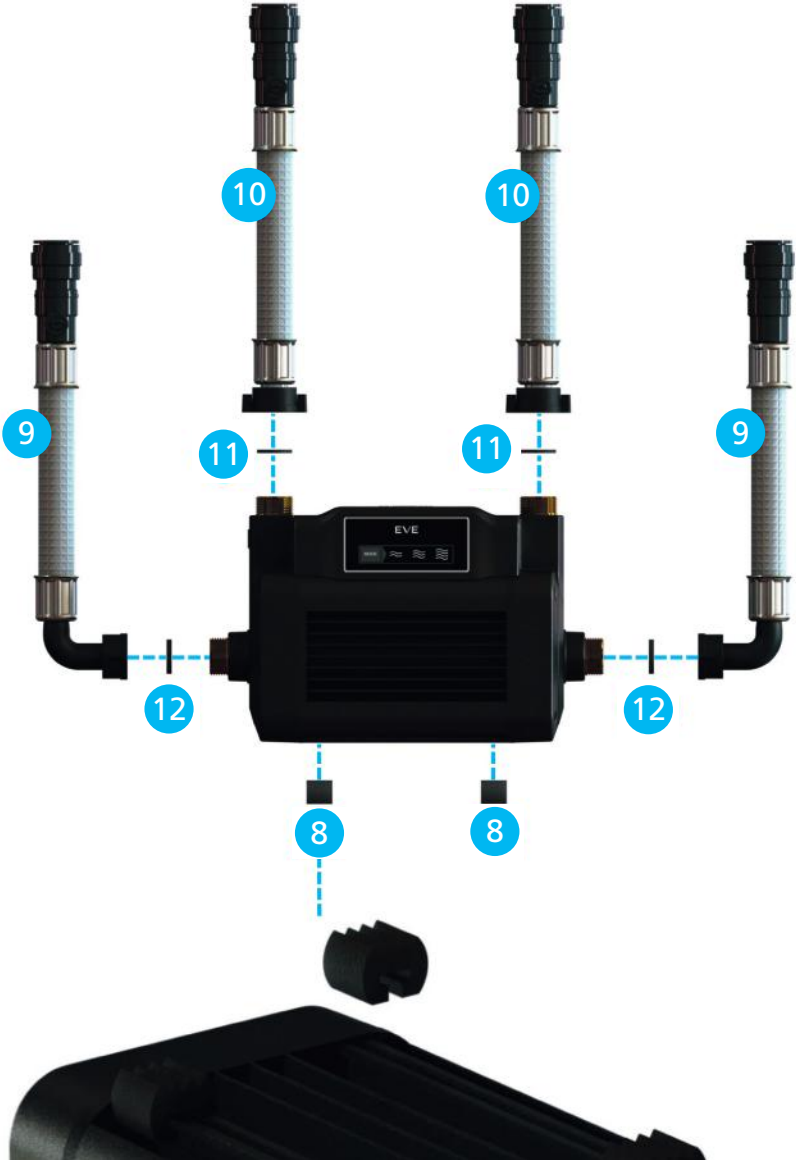

Pre-installation checklist

Our pre-installation guidelines are detailed on the following pages, but some of the key “do’s and don’ts” are highlighted below

Do’s

- Locate the pump next to the hot water cylinder OR no further than 4m away in 22mm pipe work
- Fit an equilibrium ball valve if you are pumping to toilet systems
- Allow 100mm on all sides for ventilation
- Ensure pump is protected from frost
- If servicing two or more bathrooms, cold water supply to the cylinder must be in 28mm pipe work
- Ensure adequate cold water storage. For your bathroom, or en-suite. (See Tank Specification)
- Cold water supplies to the pump must be taken from the opposite side of the cold water storage tank to the cold water mains inlet
- Multiple cold water storage tanks must be linked in accordance with current regulations and the bottom of the tanks must be at the same level
- Hot water supply to the pump must be via a Salamander approved flange
- AV couplers must only be finger tight plus one quarter turn.
- The maximum static head should be 10m (equivalent to 100kPa/1.0 bar pressure)
- EVE will automatically activate for 3 seconds after 24 hours of inactivity

Don’ts

- Never turn on the pump when there is flow through the pump
- Never fit the pump to the cold water mains
- Never fit the pump to communal risers
- Never use a shared water supply
- Never put a non-return valve (NRV), inverted loop, restrictive ballofix or an air vent on supply pipe work to the pump
- The hot water supply to the pump must not exceed 65oC
- Never twist the anti-vibration (AV) couplers or bend more than 35 degrees
- Never use mechanical tools to tighten coupler nuts as this may cause damage and will invalidate your warranty
- Never use jointing compounds, Boss White, Hemp or steel wool
- Solder fluxes must not come into contact with the pump or AV couplers
- Never install in a bathroom unless in an enclosed space and access is only possible with an appropriate tool
- Never pump directly to or from another pump
- Never connect to a secondary return tapping on a hot water cylinder without a dip tube
- Never fit pumps to a Fortic type, primatic cylinder, or Andrews type water heater

Installation Instructions

Plumbing

The installation must comply with the relevant requirements or local bye-laws.

The pump MUST be mounted upright (shaft horizontal – not screwed down). Pump must be adequately vented, protected from frost, with access provided for servicing.

Jointing compounds, Boss White, Hemp and Steel Wool, MUST NOT BE USED. SOLDER FLUXES MUST NOT COME INTO CONTACT WITH THE PUMP (THIS WILL INVALIDATE YOUR WARRANTY).

All associated pipework MUST be thoroughly flushed before making final connections to the pump. Fill the pump with water before connecting to the discharge pipework.

The in-line filters must be fitted into the hose connections on the hot and cold inlet supplies to the pump.

MAXIMUM STATIC HEAD – 10 METRES.

In ALL pump systems it is essential to ensure that the hot and cold stored water capacity is sufficient to meet the household requirements.

Hose connections (do not bend)

Fitted with 3/4" BSP x 22mm Push Fit couplers

The coupler nuts need only be finger tight plus one quarter turn. Mechanical tools must not be used to tighten coupler nuts as this may cause damage which will invalidate your warranty.

The hoses are supplied – two each angled and straight with each pump.

This arrangement of couplers facilitates the connection of the supply pipework from any direction.

The Plumbing installation must comply with "The Water Supply (Water Fittings) Regulations, BS 8558:20418. BSEN806.4 building regulations.

Electrical

The electrical installation must be carried out in accordance with the current national electrical regulations (BS 7671:2018, Building (Scotland) Act 2003, or Building Regulations (Northern Ireland) 2000). This pump must be installed by a competent person, and must be fitted with a 5A rated fuse. Higher rated fuses MUST NOT be used.

All pipework must be cross-bonded in accordance with IET regulations.

The motor shell will become hot during pump operation. DO NOT allow the mains supply cable to come into contact with it or any other hot surfaces (e.g. the pump or pipework). To ensure this, the cable must be safely routed and securely fastened with cable clips.

Cooling and ventilation

The pump should be placed in a position where there is an adequate air flow to cool the motor and separated from any other appliances that generate heat. It should be installed in a clear space allowing 100mm additional space at each side, end and top of the pump.

Typical installations

Multiple Cold Water Storage (CWS) Tanks MUST BE linked top and bottom in 28mm pipework and fitted with float operated valves in all tanks, or linked to comply with the Water Supply and fitting Regulations (1999)

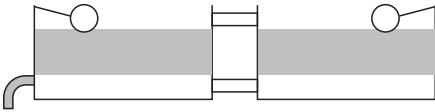

NEVER put a non-return valve; inverted loop; restrictive ballcock or an air vent on the supply pipework to a pump.

The hot water connection from the cylinder MUST BE either;

- **A 3/4" NO STOP ESSEX FLANGE**
- **An S FLANGE**
- **A YORK FLANGE (may only be used in systems where the hot water requirement is less than 20l/min)**
- **A WARIX FLANGE as long as the following criteria is met;**

- i. The vent connection must be from the side.
- ii. The supply connection to the pump MUST BE FROM THE TOP of the Warix flange via a 22mm compression elbow to avoid inverted loops.

LOFT MOUNTED PUMPS MUST BE PROTECTED AGAINST FROST DAMAGE.

EVE installed at the base of the hot water cylinder

These numbers relate to figure 1

1. Cold water storage tank fitted to current standards – capacity should be enough for your requirements per bathroom or per shower room or en-suite – Ball valve should fill on an opposite side of the tank to the pump feed and any other cold services.
2. Vent/expansion pipe fitted and terminated to current regulations
3. The pump should be fitted at least 600mm below the base of the cold water tank
4. Hot water outlet from pump – multiple options
5. Cold water outlet from pump – multiple options
6. The hot water connection should be via a suitable flange to prevent aeration in the pump, such as Essex Flange, which is the best option when the pump is above the cylinder, Salamander S-Flange, Surrey Flange, Warix Flange – where the pump is positioned above the hot water cylinder, an anti-gravity loop of 400mm should also be fitted
7. Maximum hot water temperature should be 65°C and independently controlled with a cylinder thermostat, HWSTMV (thermostatic mixing valve) or other suitable alternative
8. Hot water inlet to pump – multiple options
9. Cold water inlet to pump – multiple options
10. Incoming cold water mains
11. Pump should not be situated more than 4 metres away, in measured 22mm pipework, from the hot water cylinder

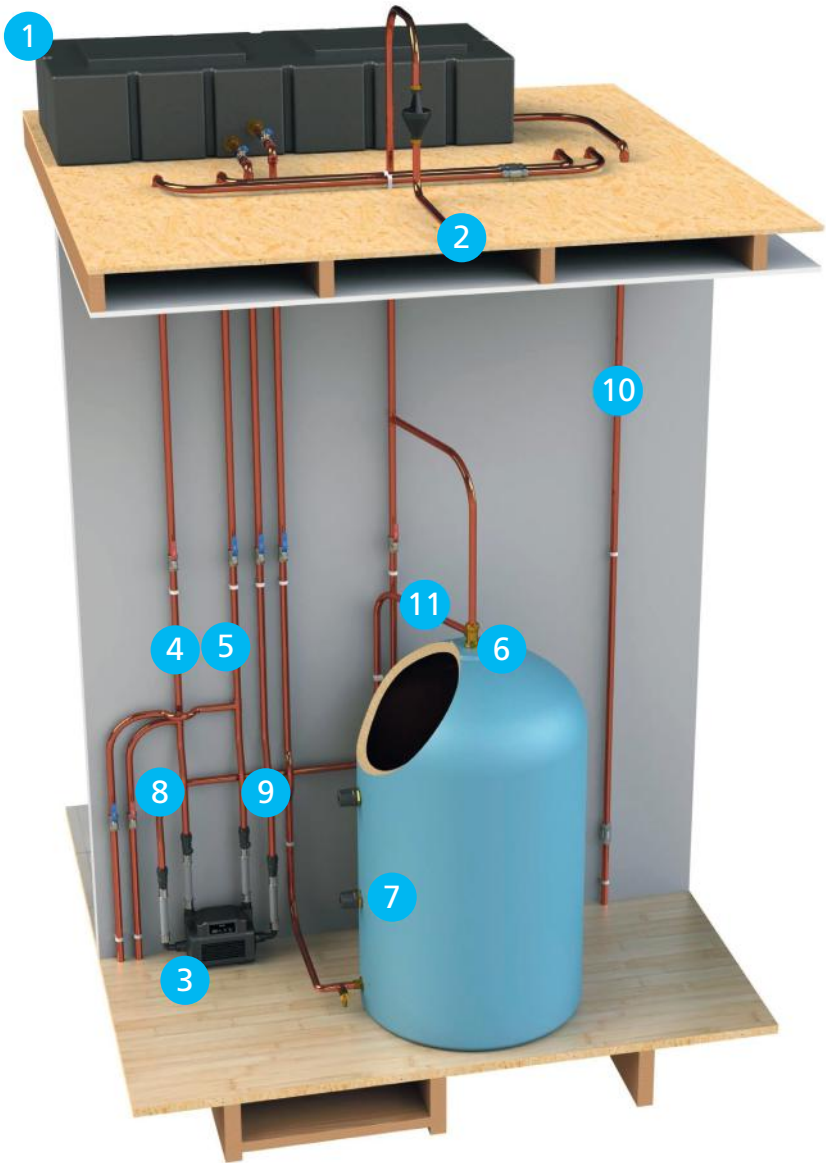

Figure 1.



Figure 2.

EVE installed above the hot water cylinder

These numbers relate to figure 2.

1. All up and over pipe work must be vented at the highest point on the outlet of the pump.
2. The pump should be fitted at least 600mm below the base of the cold water tank.
3. An anti-gravity loop at least 400mm in depth **MUST BE** fitted to all systems where the pump is mounted above the hot outlet from the cylinder.
4. Vents and other services
5. A 22mm NO STOP ESSEX flange with dip pipe and bird beak end to limit air being drawn into the pump, is the best option where the pump is mounted above the hot outlet from the cylinder.

Operating Instructions

Before you finish

Commissioning

- First flush inlet pipework and carefully fill pump with water by discharging water from the outlet flexible hose into a container
- If it is a negative head system, no flow will naturally come from shower. In this setup it is **CRITICAL** to do the following:

Discharge water through the pump into a container before connecting the pump to outlet pipework in order to ensure the air has been discharged from inlet pipework and pump chambers. This will not happen if the outlet pipework is connected to the pump.

- Fit pump inlet filters
- Connect discharge pipework
- **Check that all the pump isolating valves are open**
- Fill system. Check for leaks
- **DO NOT RUN PUMP DRY** – to do so will cause irreparable damage to your pump and will **invalidate your warranty**

MODE selection

The output pressure of the pump can be varied through three user-selectable modes:

- MODE 1:** EVE will maintain an outlet pressure of **1.5bar** up to 40L/min by dynamically changing speed.
- MODE 2:** EVE will maintain an outlet pressure of **2bar** up to 40L/min by dynamically changing speed.
- MODE 3:** EVE will produce an outlet pressure of **3bar** by static speed performance.

N.B. – In the dynamic modes, the pump will increase motor speed, to maintain the pressure for increased flows. So a tap turning on elsewhere, won't mean your shower loses pressure. EVE will speed up to adjust for it.

All modes can be used in positive head and negative head installation types.

To change the mode:

N.B. - The mode can only be changed whilst the EVE is ON and not running (no flow).

1. TOUCH and HOLD the MODE selector until the next mode LED comes on
 - STOP PRESSING MODE
2. TOUCH again to move on to the next mode.
 - STOP PRESSING MODE

Every time the next mode is selected, the LED ring flashes and the mode selected stays lit.

The MODE sequence is as follows:
1-2-3-1-2-3-1-2...etc



General Specification

Applications

EVE is designed to boost low pressure hot and cold supplies from tank-fed services.

Voltage

220-240 volts 50 Hz.

Motor type

Brushless DC motor with stainless steel shaft

Pump materials

Moulded components are manufactured from BMC, ABS. The motor body is aluminium.

Maximum head

10 metres

Pump noise

No pump is completely silent.
Correct installation will minimise vibration and transmission noise.

Patents

EVE is protected by the following patents:
GB2402444
GB2517719
GB2465392
GB2402444

Mechanical seals

Scale deposits in water supplies can cause the mechanical seal to stick if left for long periods without use. EVE automatically runs for 3 seconds after 24 hours of inactivity.

Connections

3/4" BSP male.

Initiation

Fully automatic, pressure sensor operated, requiring a drop in pressure.

Temperature

Maximum fluid temperature 65°C.
Minimum fluid temperature 5°C

Standards and approvals

Splash proof rating IPX2.
Complies with the requirements of current British and European safety standards for household and similar electrical appliances.
Complies with European Community Directives (CE).

The company operate a policy of continuous development and reserves the right to change any of the specifications of its products without prior notice. All information data and illustrations given in this leaflet may be subject to variation.

Tank Specification









EVE's enhanced dynamic performance enables multiple outlet to be fed with a set pressure. To enable this performance please ensure the system has enough stored water. The table below shows how long different volumes of water will last at maximum flow rate. Max flow will occur where multiple outlets are open, e.g, 2 showers or bath and shower. Typical usage will be less.

Tank size		Tank drain time (mins)
Gallons	Litres	At MAX flow 40lpm
25	114	4.5*
50	227	9*
70	318	13*
100	455	18*

*Time based on tank replenishment rate of 15lpm

Pump Mode		1	2	3
General	Guarantee	3 years		
Features	Pump type	Centrifugal		
	Mechanical seal	Nitrile/Carbon/Ceramic		
	Inlet isolator(s)	Included		
	Flexible hose	4		
	Dry run protection	Included		
Performance	Pressure @ 16lpm	1.5bar	2bar	2.7bar
	Pressure @ 8lpm	1.5bar	2bar	2.85bar
	Pressure @ closed	1.5bar	2bar	3bar
	Maximum water temperature	65°C		
Connections	Pump connections	3/4" BSP		
Flexible hoses	Connections (UK model)	3/4 Female x 22mm push-fit x 280mm long, isolating valves on all hoses		
Motor	Type	Brushless DC		
	Duty rating	Continuously Rated		
Electrical	Power supply	230V		
	Current (full load)	4.11A		
	Power consumption	662W		
	Fuse rating	5A		
	Power cable (pre-wired)	1.5 meters		
Physical	Enclosed protection (IP rating)	IPX2		
	Length	275mm		
	Width	120mm		
	Height (excluding hoses)	180mm		
	Weight (excluding hoses)	4.3Kg		

Trouble shooting

Error Code	Likely Problems	Solution
Flash 	Eve is detecting a potential dripping tap, or slow system leak.	Find the dripping tap, or system leak, and repair. Once the issue has been identified and resolved, the pump should be isolated from the mains for 1 minute, then reconnected, to reset the lockout.
Steady 	A drip or system leak has been found. Protection has been initiated, and the pump has locked out.	
Flash 	EVE is detecting aeration or water starvation in pump chambers.	Find the restriction on input flow, or air leak, and repair. Once the issue has been identified and resolved, the pump should be isolated from the mains for 1 minute, then reconnected, to reset the lockout.
Steady 	Excessive aeration or water starvation has been found. Protection has been initiated, and the pump has locked out.	
Flash 	EVE is regulating the motor speed in order to cool, and maintain pump performance.	Find the reason for the pump overheating, and allow to cool. Once the issue has been identified and resolved, the pump should be isolated from the mains for 1 minute, then reconnected, to reset the lockout.
Steady 	An issue with overheating has been found. Protection has been initiated, and the pump has locked out.	
Flash 	Mains Voltage input, the mains input is varying beyond pump limits, or the mains has been disconnected.	Find the reason for the variation in mains inlet voltage, and repair.
Steady 	There is a motor fault. Either a restriction or blockage of the motor.	Possible restriction to the impeller, contact PumpWise 0191 516 2002

Fault	Probable cause	Recommended solution
Pump will not start	Electrical	Check power supply
		Check fuse
		Check circuit breaker
	Inlet/outlet connections incorrect	Check that connections are plumbed the correct way round and all valves are open
	Float sticking in outlet Flow switch malfunction	Ensure no debris is in outlet area Contact our technical advisors on 0191 516 2002
Reduced/ intermittent flow	Incorrect or no anti-aeration flange fitted	Check that installation complies with Salamander instructions
	Blocked inlet filters	Ensure that all filters and shower head are free from debris
	Couplers restricting flow	Ensure that all AV couplers are straight and not bent or distorted
	Air in system	Run system on full hot with pump switched off (i.e. gravity only) for several minutes. Check cold water storage is correct for installation and pump is fitted to Salamander instructions. Ensure cold water refill rate is adequate for installation. Check that vents are fitted as described in instructions.
	Wrong size pump for system	Ensure pump is sufficient to run the equipment
	Hot temp set too high	Reduce cylinder stat setting to 65°C max or fit HWS/TMV
Pump starts with all outlets closed	Leak in system	Check for leaks
	Outlet open	Ensure all outlets are fully closed or capped – i.e. no dead legs in pipework
Pump is noisy	Air in system	See previous page
	Pump vibrating on surface	Ensure rubber feet are fitted to pump
	AV couplers causing vibration	Ensure that all AV couplers are straight and not bent or distorted
Pump is leaking	Pump exposed to mains water pressure	Check that installation complies with Salamander instructions
	Pump has suffered chemical damage	Ensure that the pump has not come into contact with chemical substance i.e. solder flux
	Pump exposed to excessive temperature	Is effective temp control fitted (cylinder stat or HWS/TMV valve)?
	Pump appears to have leaked but not sure	Check leak is not from fitting in pipework above pump
Pumps above hot cylinder becomes noisy/low pressure during use	Aeration or water starvation	An Essex flange may be required for the hot connection to cylinder. Ensure pump is a minimum of 600mm below the cold water tank.



0191 516 2002

Monday to Thursday 8.00am to 5.30pm
Friday 8.00am to 5.00pm.

PumpWise is the cornerstone of Salamander Pumps support service to customers and the means by which our customers are guaranteed:

Selection of the right pump for the job

– With more than 30 pumps in our range, the PumpWise team can help you to choose the pump that's most suitable to your specific installation

The avoidance of installation pitfalls

– Due to the technical nature of our products, it is essential that they are fitted according to our installation guidelines. The PumpWise team are available to talk through any installation questions and provide technical support and guidance.

Our PumpWise commitment

Our PumpWise helpline is here to help you and we aim to provide a support service second to none. Installers and customers can be sure of a speedy response to requests for technical help, guidance and advice.

Your warranty

Salamander customers benefit from a full 3 year warranty on EVE.

This warranty will operate from the date of purchase and is subject to the installation guidelines being followed correctly (please refer to our Pre-Installation Checklist and our Commissioning Checklist.) Providing the pump has been installed according to our guidelines, you will receive a 3 year warranty free of charge (UK only).

Please complete the online warranty form at:

www.salamanderpumps.co.uk

Telephone: 0191 516 2002

Fax: 0191 548 4445

Email: tech@salamanderpumps.co.uk

PLEASE NOTE: Incorrect installation may invalidate the pump warranty.

Please read the full terms and conditions.

To the installer

Please follow the guidelines for installation provided in this brochure and call the PumpWise helpline for installation advice. Once installation has been completed and the system has been tested to your satisfaction, please assist the customer in completing the online Warranty Card.

Terms, conditions and warranty

1 The Scope of the Warranty

SALAMANDER PUMPED SHOWER SYSTEMS LTD ("the company") Warrants subject to the terms and conditions below for the Warranty period(s) specified in paragraph 3 that the Company shall: Repair or replace free of charge the product(s) specified on the Warranty form or any component part thereof (together referred to as "the equipment") which shall in the opinion of the Company have proved defective by reason only of the Company's materials or workmanship providing always that the Company shall be under no obligation whatsoever under this Warranty to repair or replace equipment which have been misused, tampered with, modified/altered in any way without the consent in writing of the Company or if any component or accessory shall have been replaced by a type not specified by the Company or if the equipment is incorrectly installed or operated or used other than as described in the instruction manual or if any servicing or repair of the equipment shall have been carried out otherwise than by an authorised Company dealer appointed by the Company ("dealer").

The Company's liability under this Warranty is limited to the said repairs or replacement and shall under no circumstances extend to any financial loss or damage including consequential losses alleged to have been suffered by the claimant.

Subject as provided in this warranty and except where the equipment is sold to a person dealing as a consumer all warranties, conditions or other terms implied by law are excluded to the fullest extent permitted by law.

Nothing in this warranty shall exclude liability for death or personal injury caused by the Company's negligence.

2 Terms and conditions

This Warranty shall only be enforceable by you if the following terms and conditions have been complied with:

That the pump has been installed in accordance with the installation instructions, guidance and advice contained within the installation and warranty guide and/or provided by the Salamander help desk.

You are the original purchaser of the equipment from a dealer and not an assignee or subsequent purchaser of the equipment.

You must evidence the date of purchase by retaining the original invoice from the dealer. Without such evidence the Company reserves the right to reject any such claims under the terms of this Warranty. Within 15 days of delivery of the equipment to you the Warranty form is accurately completed.

Within 30 days of discovery of a defect giving rise to liability under paragraph 1 above you give notice thereof in writing to the Company.

Provided the pump has not been altered, tampered with, modified or transformed in any way.

3 The Warranty periods

The Warranty periods referred to in paragraph 1 above are as follows:

Products manufactured by the Company 3 years from date of purchase provided the warranty is completed and returned to the Company within 15 days of purchase.

Products supplied by the company, but are not of the company's manufacture come with 30 day warranty from date of purchase. Anti-Vibration Couplers (hoses) come with 1 year from date of purchase.

The warranty period in respect of any product repaired or replaced under the warranty shall be part of the above period(s) which remain unexpired.

In the event of a claim for repairs or replacement being made under the terms of this Warranty, a visit from a Salamander service engineer may be necessary. Engineer visits are not covered under/part of the warranty agreement. In circumstances where in the opinion of the Company the defect has not been caused by the Company's materials or workmanship, then the Company reserves the right to charge the claimant at its current hourly rates and list prices in respect of any service engineer's time and replacement of any parts. Please speak to our Technical Support team for further details and confirmation of costs.

This Warranty is given in addition to and does not affect your statutory rights as a consumer.

This Warranty is valid and enforceable for equipment purchased and used exclusively within the UK and the Republic of Ireland only.

Where the Company issues a replacement the equipment replaced shall be returned to the Company forthwith and shall become the property of the Company.

No authority has been given to any person, firm or company to vary the terms of this Warranty.

Disposal Instructions

Your appliance contains valuable materials which could be recovered or recycled. At the end of the products useful life please dispose of it at an appropriate civic waste collection point.

Get in touch, we're here to help
call us on 0191 516 2002

Unit 2c Colima Avenue
Enterprise Park West
Sunderland, SR5 3XE



Register your warranty

Apply online at:

www.salamanderpumps.co.uk

Apply by phone:

0191 516 2002

